

SPECIFICATION	CONNECTION	UNIPOLAR	BIPOLAR (SERIAL)	BIPOLAR (PARALLEL)
VOTAGE(VOC)		5.70	8.00	4.10
AMPS/PHASE		1.00	0.70	1.40
RESISTANCE/PHASE(Ohms)@25°C		5.70±10%	11.40±10%	2.90±10%
INDUCTANCE/PHASE(mH)@1KHz		5.50±20%	22.00±20%	5.50±20%
HOLDING TORQUE(Nm)[lb-in]		0.43[3.81]	0.60[5.31]	0.60[5.31]
STEP ANGLE(°)		1.80		
STEP ACCURACY(NON-ACCUM)		±5.00%		
ROTOR INERTIA(g-cm ²)		128.00		
WEIGHT(Kg)[lb]		0.50[1.10]		
TEMPERATURE RISE:MAX.80°C (MOTOR STANDSTILL;FOR 2PHASE ENERGIZED)				
AMBIENT TEMPERATURE -10°C~50°C[14°F~122°F]				
INSULATION RESISTANCE 100 Mohm (UNDER NORMAL TEMPERATURE AND HUMIDITY)				
INSULATION CLASS B 130°C[266°F]				
DIELECTRIC STRENGTH 500VAC FOR 1MIN.(BETWEEN THE MOTOR COILS AND THE MOTOR CASE)				
AMBIENT HUMIDITY MAX.85%(NO CONDENSATION)				

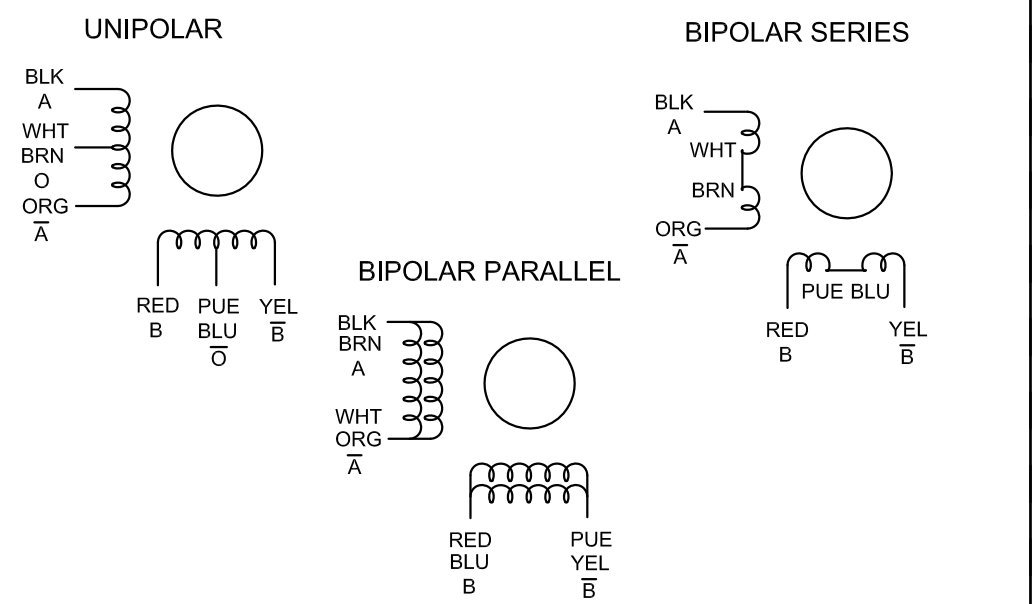

APVD		
CHKD		
1:1.5	DRN	
SCALE	SIGNATURE	DATE

STEPPER MOTOR

23HS17-1008S