

SPECIFICATION	CONNECTION	UNIPOLAR	BIPOLAR (SERIAL)	BIPOLAR (PARALLEL)
VOTAGE(VOC)		4.80	6.78	3.39
AMPS/PHASE		3.00	2.12	4.24
RESISTANCE/PHASE(Ohms)@25°C		1.60±10%	3.20±10%	0.80±10%
INDUCTANCE/PHASE(mH)@1KHz		8.00±20%	32.00±20%	8.00±20%
HOLDING TORQUE(Nm)[lb-in]		5.00[44.25]	7.07[62.57]	7.07[62.57]
STEP ANGLE(°)		1.80		
STEP ACCURACY(NON-ACCUM)		±5.00%		
ROTOR INERTIA(g-cm²)		1800.00		
WEIGHT(Kg)[lb]		3.13[6.90]		
TEMPERATURE RISE:MAX.80°C (MOTOR STANDSTILL;FOR 2PHASE ENERGIZED)				
AMBIENT TEMPERATURE -10°C~50°C[14°F~122°F]				
INSULATION RESISTANCE 100 Mohm (UNDER NORMAL TEMPERATURE AND HUMIDITY)				
INSULATION CLASS B 130°C[266°F]				
DIELECTRIC STRENGTH 500VAC FOR 1MIN.(BETWEEN THE MOTOR COILS AND THE MOTOR CASE)				
AMBIENT HUMIDITY MAX.85%(NO CONDENSATION)				

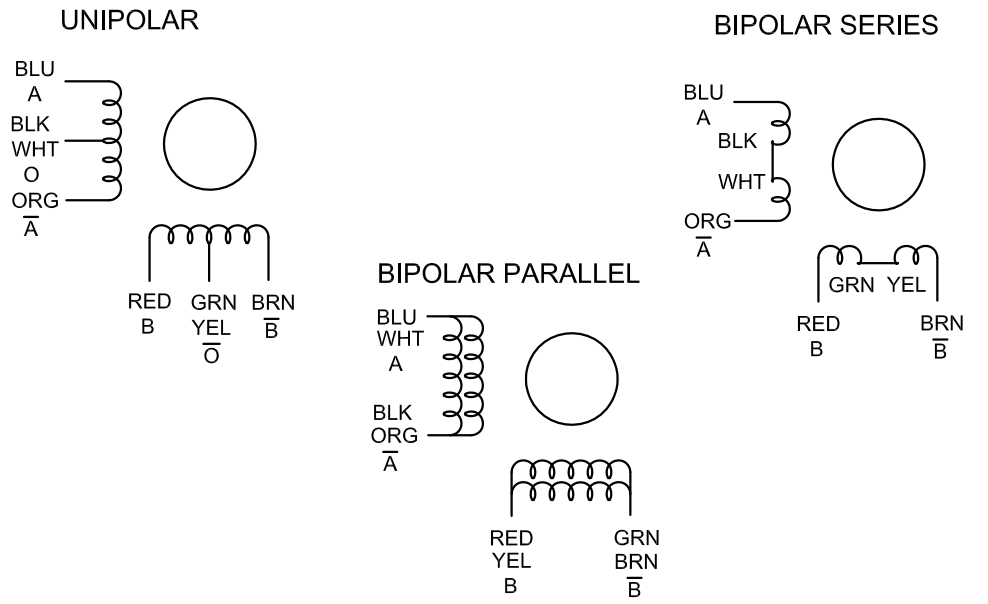

APVD		
CHKD		
1:1.5	DRN	
SCALE	SIGNATURE	DATE

STEPPER MOTOR

34HS38-3008S